

Istruzioni di montaggio

Assembly Guidelines

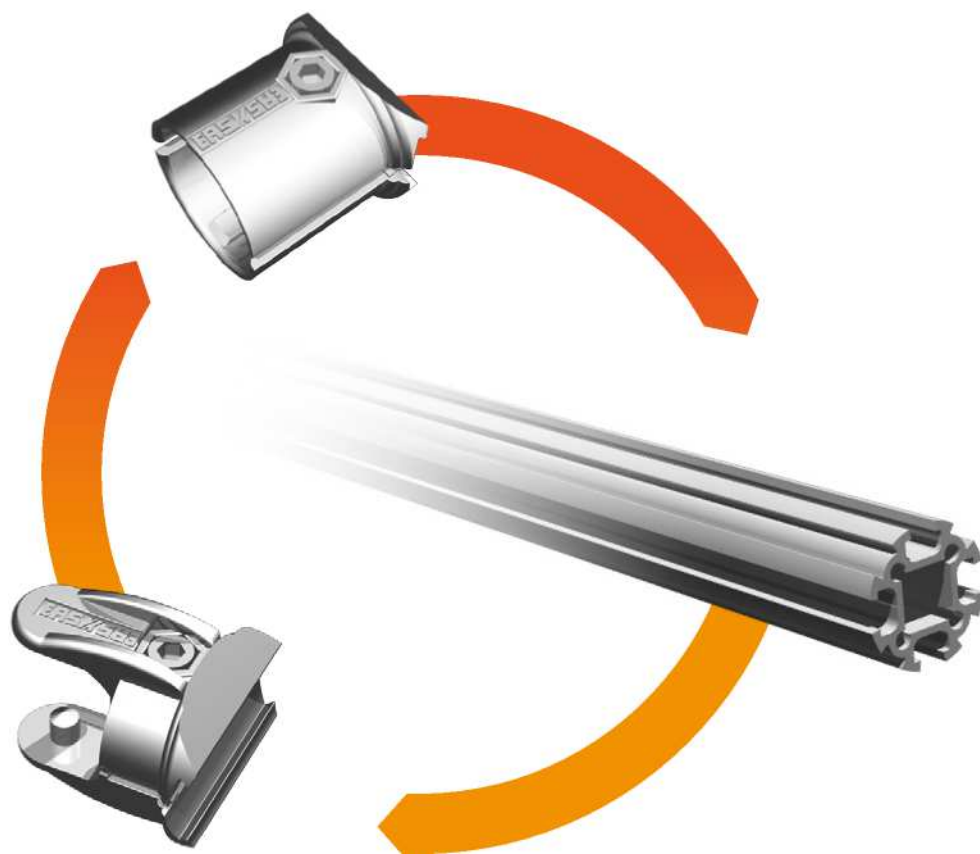

1. Preparazione giunto a 90° EKG1

Joint 90° Assembly

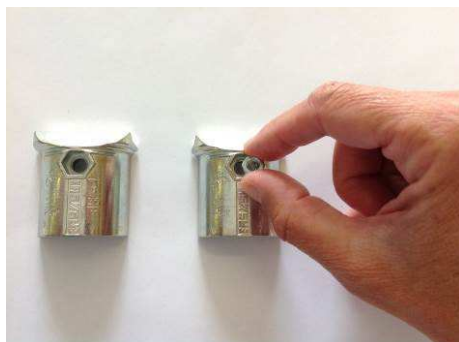

2. Preparazione giunto a 0° - 180° EKG2

Joint 0° - 180° Assembly



3. Molla EUT1 per facilitare il montaggio dei giunti

Spring Tool EUT1 for an easy Joint Fastening

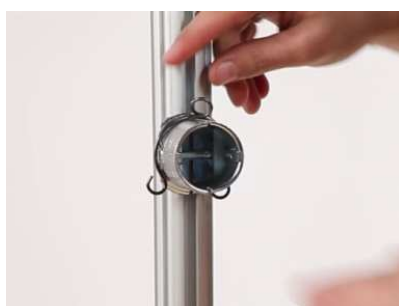

4. Unione giunto a 90° con profilo tubolare EPR1

Joint 90° / Tubular Profile EPR1 Connection

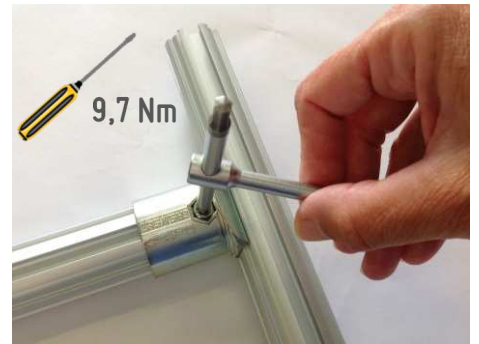
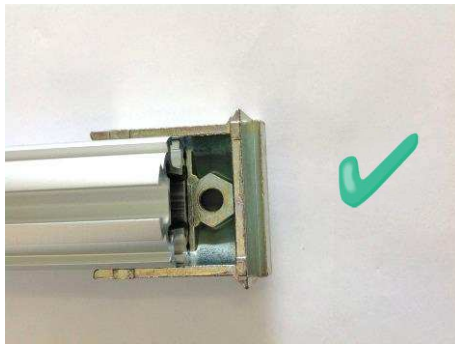
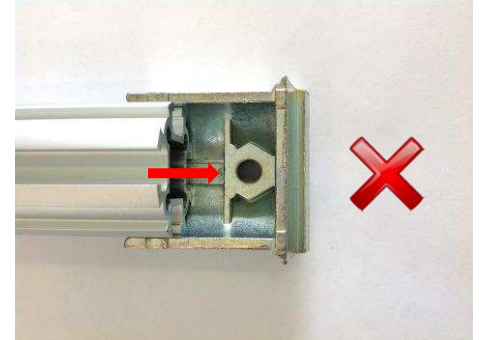

5. Unione giunto a 0° - 180° con profilo tubolare EPR1

Joint 0° - 180° / Tubular Profile EPR1 Connection

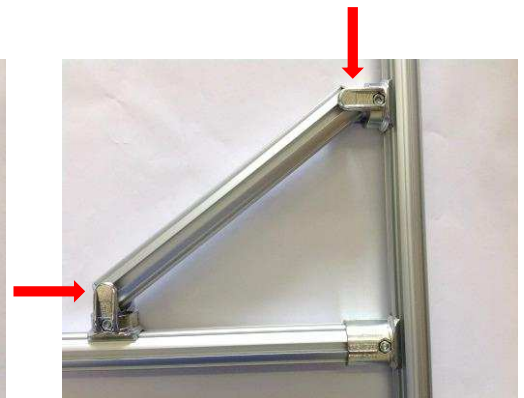

6. Preparazione ruota con perno (EKR5 & EKR6)

Swivel Stem Caster Assembly (EKR5 & EKR6)

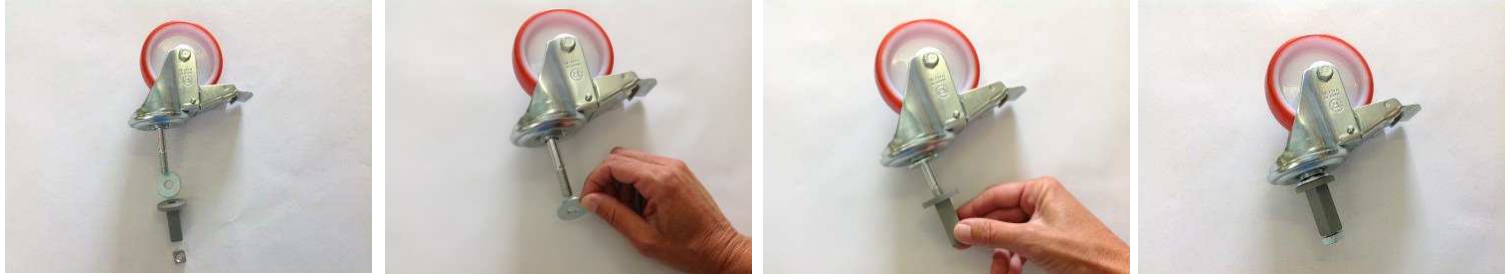

7. Preparazione ruota con piastra (EKR7 & EKR8)

Swivel Plate Caster Assembly (EKR7 & EKR8)



8. Preparazione piedino EKP1

Levelling Foot EKP1 Assembly



9. Unione piedino / ruota con profilo tubolare EPR1

Levelling Foot EKP1 Assembly

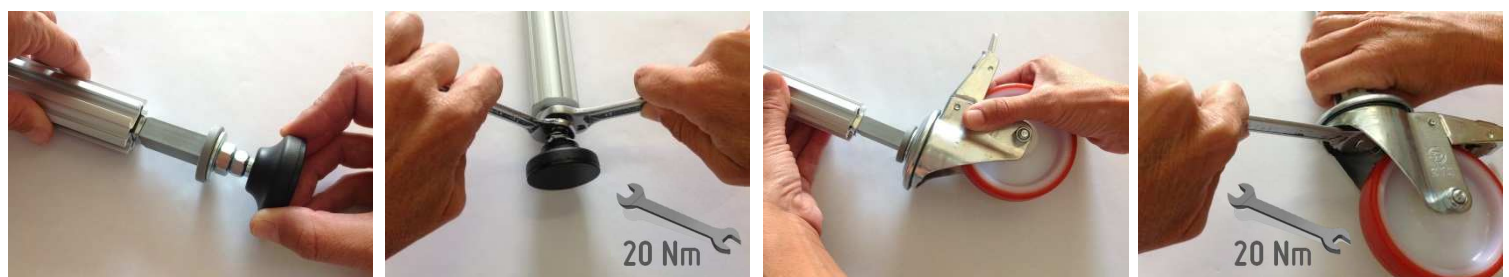

10. Montaggio rulliere

Roller Tracks Installation



Si consiglia di rimuovere le sbavature dalle barre a rullini dopo il taglio, al fine di rendere più agevole il loro montaggio

After saw cutting operation roller track ends need to be made burr free for an easier installation

Inserire i pettini a dente lungo sul profilo posteriore

Insert the plastic clip strips with long teeth in the rear profile

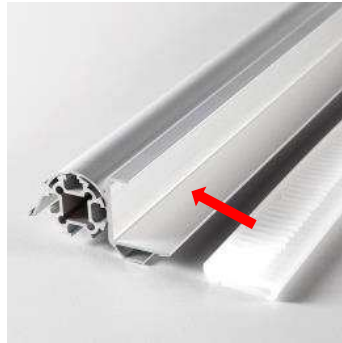

Inserire i pettini a dente corto sul profilo anteriore

Insert the plastic clip strips with short teeth in the front profile

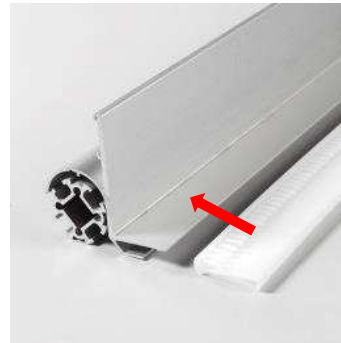

1 Inserimento a scatto dei profili sulle traverse
Snap-in mounting on the tubular profile of the rear & front profiles

2 Inserimento pettini in plastica sui profili
Add the plastic clip strips on the rear & front profiles



3 Posizionamento guida a rullini nei pettini a dente lungo
Insert the roller track in the plastic clip strip with long teeth

4 Fissaggio guida a rullini nei pettini a dente corto
Fix the roller track in the plastic clip strip with short teeth



11. Montaggio barra a rullini tramite clip di fissaggio E867

Roller Track Mounting using Mounting Clip E867

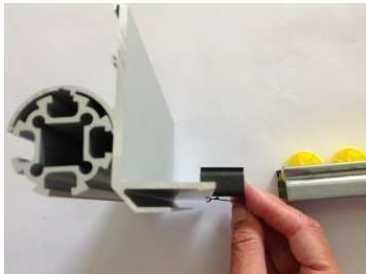

La clip di fissaggio E867 è un'alternativa ai pettini in plastica a denti lunghi e corti. Consigliabile per piani a rulli ESD

The mounting clip E867 is an alternative to the plastic clip strips with long and short teeth. Recommended for ESD flow rack levels

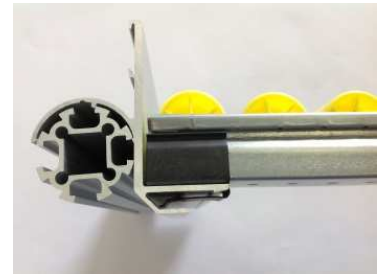

12. Montaggio molla blocco rulliere E836

Roller Track Holding Spring Clip E836 Installation

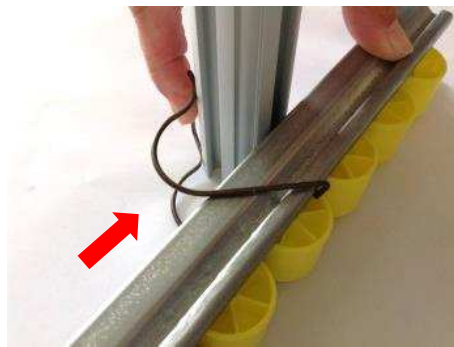

13. Montaggio guida laterale in PVC E516 / E596

PVC Lateral Guide E516 / E596 Installation

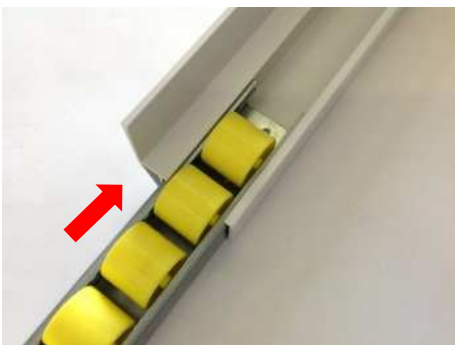

14. Montaggio guida centrale in PVC E538

PVC Central Guide E538 Installation



15. Montaggio staffe EDC833 — EDC834 — EDC835

Tilt Bars EDC833 — EDC834 — EDC835 Installation

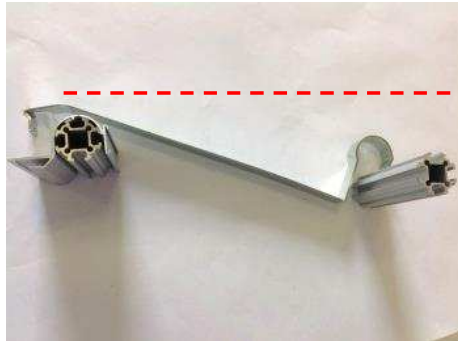

20°-35°



16. Piastra di connessione universale EDC841

Universal Connecting Plate EDC841



Utilizzabile per unire profili a sezione quadra dotati di cava con i profili tubolari EPR1

It can be used to connect the tubular profile EPR1 with square T-slotted profiles



17. Portaetichette adesivo C840

Clear self-adhesive Label Holder C840

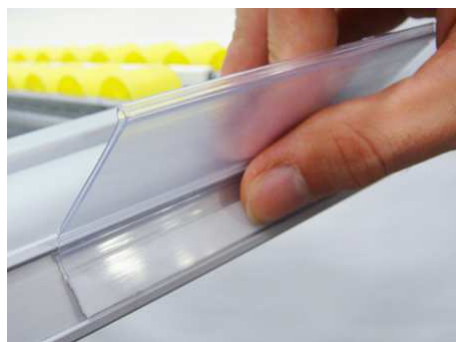
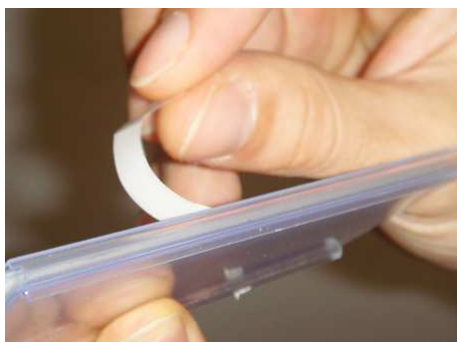

EASYSAE
made to make
PORTA ETICHETTE ADESIVO
cod. C840

18. Squadretto per fissaggio piani di lavoro EDC790

Angle Bracket for Fixing Worktops EDC790

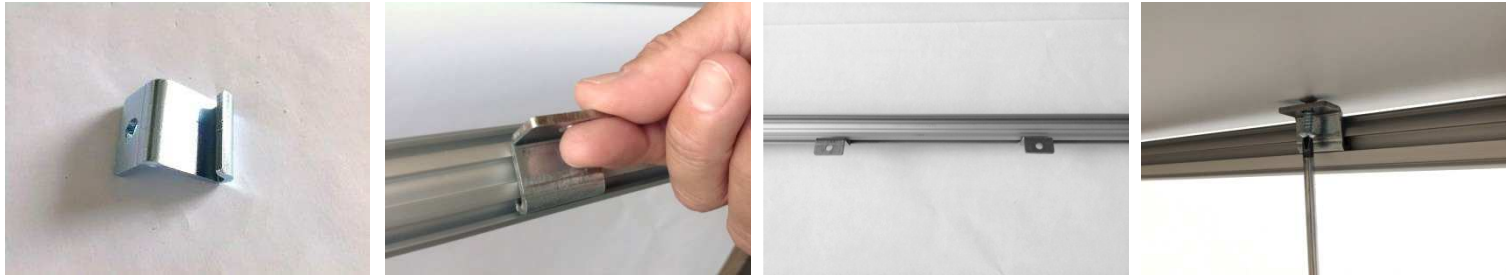

19. Maschera per il taglio dei profili supporto rulliere EUT3

Cutting Jig EUT3

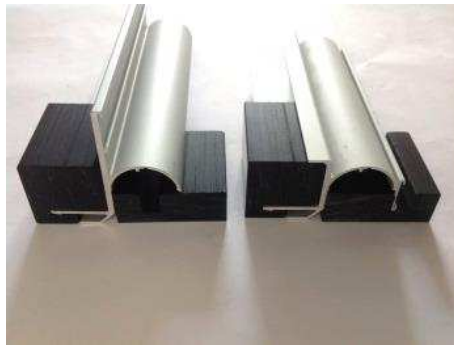

20. Utensile a forchetta EUT2

Fork Tool EUT2



Semplifica e velocizza il montaggio a scatto e lo smontaggio dei profili EPC818 & EPC820

This tool makes the EPC818 & EPC820 snap in mounting and dismantling fast and easy



21. Utensile a molla W169 per tasselli ETFX1

Fork Tool W169 for Nuts ETFX1



22. Kit per la libera rotazione dei profili EKS5

Kit for the Profiles Rotation EKS5

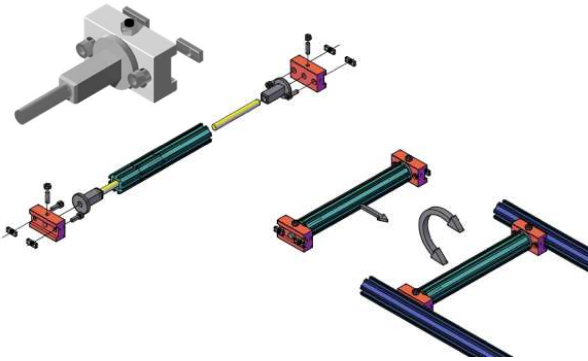

Unendo 2 kit EKS5 ad un profilo EPR1, questo resta libero di ruotare

By means of two kits EKS5, the profile EPR1 can rotate freely



Applicazione: magazzino con scambio cassette a pedale
Application: foot pedal carton flow rack

23. Consigli per il montaggio veloce di strutture

Structures Quick Assembly Tips

- 1** Montare le fiancate complete di piedi o ruote
Build side frames with feet or casters



- 2** Montare le traverse su una fiancata
Add cross-profiles



- 3** Montare la seconda fiancata
Add second side frame



- 4** Completare con eventuali piani a rullini o altri accessori
Fit roller tracks and add & secure accessories

